

LUXOR
Computers

ABC 815 Display Unit 190 9212

Service Manual

Edition 1.0 August 1981

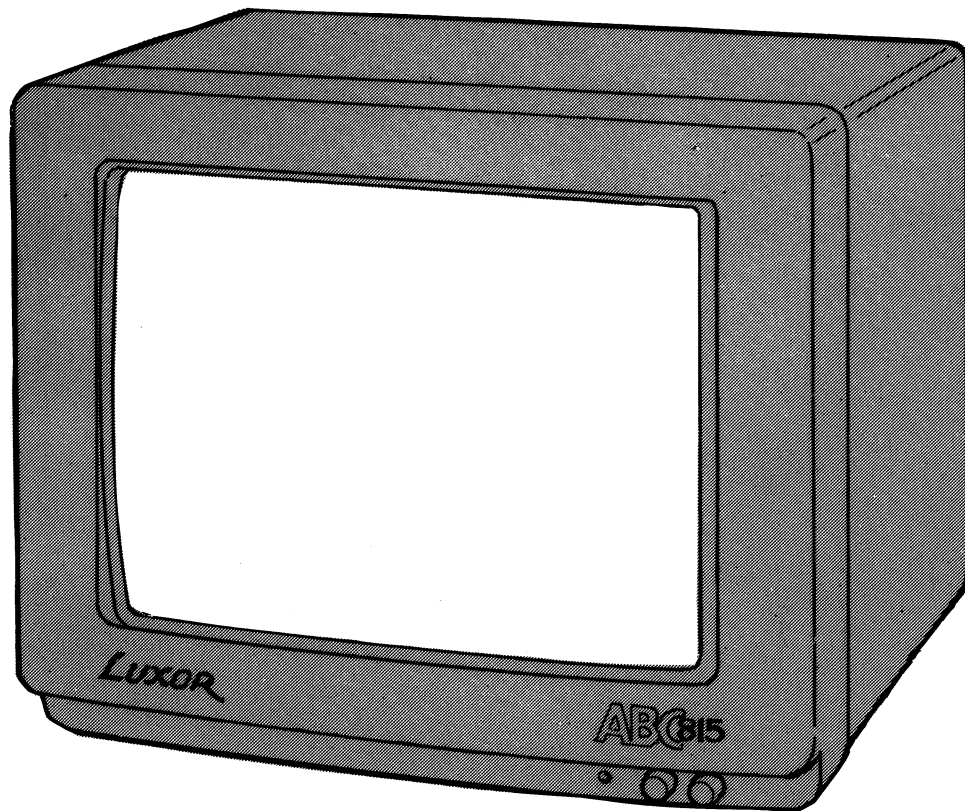

ABC800[®]

CONTENTS

Technical specifications.....	1
Technical description.....	2
1.0 General information.....	3
2.0 Function description.....	3
2.1 Video amplifier.....	3
2.2 Vertical deflection.....	4
2.3 Horizontal deflection.....	4
2.4 Brightness adjustment.....	5
2.5 Protected circuits.....	5
2.6 Inputs and outputs.....	5
2.7 Mains supply unit.....	5
Exploded view.....	6
Adjustment.....	7
P.C.board, main board.....	8
P.C.board, picture tube module.....	9
Connector XP-15.....	10
Circuit diagram.....	11
Spare parts list.....	13

TECHNICAL SPECIFICATIONS

Picture tube	Size	15"
	Defl. angle	110°
	Neck diam.	28.6 mm
	Front radius	635 mm
	Phosphor	LA
Input signal		TTL
Video	Bandwidth	35 MHz
	Rise/fall time	18/18 ns
	Resolution	1000 lines
	Amplitude (High)	4 ± 1,5 V TTL-level
	Amplitude (Low)	0 ± 0,4 V TTL-level 0 V
	Shunt resistance	300 Ω min.
	Shunt capacitance	40 pF max.
H. sync	Frequency	15,625 kHz
	Polarity	pos./neg.
	Pulse width	5 μs
	Blanking	11 μs
	Phase control	± 1,5 s
	Amplitude (High)	4 ± 1,5 V TTL
	Amplitude (Low)	0 ± 0,68 V TTL 0 V TTL
	Shunt resistance	300 Ω min.
	Shunt capacitance	40 pF max.
V. sync	Frequency	50 Hz
	Polarity	pos./neg.
	Pulse width	1 ms
	Blanking	1,1 ms
	Amplitude (High)	4 ± 1,5 V TTL
	Amplitude (Low)	0 ± 0,4 V 0 V
	Shunt resistance	300 Ω min.
E.H.T.		17 kV
Dynamic focusing		Hor. + Vert.
Mains supply voltage		198-242 V AC
frequency		50 Hz
power consumption		40/80 W
Defl. linearity	H.	± 6%
	V.	± 6%
Raster distortion	H.	1,5 % max.
	V.	1,5 % max.

TECHNICAL DESCRIPTION

ABC 815

- 1.0 General information
- 2.0 Function description
 - 2.1.0 Video amplifier
 - 2.1.1 Video, Reverse Video
 - 2.1.2 Dim. Reverse Dim.
 - 2.1.3 Retrace blanking
 - 2.1.4 Step response
 - 2.2 Vertical deflection
 - 2.2.1 Frame rate
 - 2.2.2 Picture height, linearity
 - 2.2.3 Centring
 - 2.2.4 Synchronizing
 - 2.3 Horizontal deflection
 - 2.3.1 Synchronizing
 - 2.3.2 Horizontal frequency, phase position
 - 2.3.3 Picture width
 - 2.3.4 Linearity
 - 2.3.5 Focusing, dynamic
 - 2.4 Brightness adjustment
 - 2.5 Protected circuits
 - 2.6 Inputs and outputs
 - 2.7 Mains supply unit

1.0 General information

This monitor is a fully transistorized display unit for use in systems requiring high video quality.

The monitor is built on a P.C. board, which together with an advanced integration ensures high reliability and uniform quality.

All inputs have been designed in such a way that they are easily adjustable for different polarities and signal combinations.

The monitor can be synchronized with separate horizontal- and vertical sync pulses as well as with composite sync pulses or with composite video + sync pulses.

2.0 Function description

2.1 The video amplifier

The video amplifier consists of TP01 and TP02. These are driven by the gates ICW01c and ICW01d via RW15, CTW01, PW01, RW08 and CW01.

2.1.1 Video, Video Reverse

The video signal (TTL level) is connected to pin 5 of the connector K1 (VIDEO). The polarity of the output of the gate ICW01d, can be controlled with a TTL signal that is connected to pin 6 of the connector K1 (VIDEO REVERSE). A fixed polarity can be selected by means of switch 03.

2.1.2 Dim, Dim Reverse

By means of the gate ICW01c, another signal (TTL), that is connected to pin 4 K1 (DIM) can be added to the main signal. In this way the light intensity of certain characters can be increased or reduced. This is controlled by the signal on pin 3 K1 (DIM REVERSE). The amplitude of the DIM-signal is controlled by PW01 (contrast).

2.1.3 Retrace Blanking

The pulses for vertical and horizontal retrace blanking are added to the video signal by means of transistor TW01. The horizontal retrace blanking pulse is taken from pin 8 of TDA2591 and the vertical pulse from pin 3 of TDA1170.

2.1.4 Step Response

The step response of the video channel can be adjusted by means of trimmer CTW01.

A corresponding method of adjustment does not exist for the step response of the DIM channel.

2.2 Vertical Deflection

Vertical deflection occurs by means of the IC TDA1170, which drives the required current through the deflection coil. TDA1170 also contains vertical oscillator, saw-tooth generator and drive circuits.

2.2.1 Frame Rate

The frame rate, normally 50 Hz, can be adjusted with PV01.

2.2.2 Picture Height, Linearity

The required picture height can be set with PV03 and the linearity with PV02.

2.2.3 Centring

The raster can be moved vertically, in relation to the display screen, with PV04 and also laterally with the ring-shaped magnets on the deflection unit.

2.2.4 Synchronizing

Synchronizing pulses, positive or negative, are fed to pin 8 of TDA1170. Internal or external sync source can be selected by means of 04.

2.3 Horizontal Deflection

The horizontal deflection is carried out by means of TH02 and DH04, which drives the required current through the horizontal deflection winding. TV01 is a drive transistor, which supplies base current to TH02 via LH01. In addition to the E.H.T., filament current and electrode voltages to the picture tube, the line transformer also supplies a number of auxiliary pulses for synchronizing, d.c. voltage to the video output stage etc.

2.3.1 Synchronizing

Horizontal sync pulses are fed to pin 9 of the horizontal oscillator circuit TDA2591. These pulses must always be positive. Correct polarity can be selected by means of 01. TDA2591 contains a normal TV sync separator, wherefore it is also possible to have composite horizontal- and vertical sync pulses on pin 9, which pulses are then separated in TDA2591.

2.3.2 Horizontal frequency, phase position

The nominal horizontal deflection frequency is 15.625 Hz, which is set by means of SP02. The phase position of the picture in relation to the raster can be adjusted with SP01.

2.3.3 Picture width

Picture width can be adjusted with LH03 and, to some extent, with PN01.

(NB! PN01 also affects the E.H.T.)

2.3.4 Linearity

The horizontal linearity is adjusted with LH04. (H-Lin)
LH04 also affects the picture width and it is therefore necessary to adjust LH03 and LH04 alternatingly to obtain the required result.

2.3.5 Focusing

Static focusing is carried out by means of PH03. On the voltage set by PH03, are superimposed two parabola shaped voltages, one of vertical frequency and one of horizontal frequency, which are generated by TH04, TH05 and TH06. The working point can be adjusted for symmetrical pulses by means of PH02.

2.4 Brightness setting

Master brightness is set by means of PH01. Required brightness is on the other hand set by means of PH05 on the front panel.

2.5 Protective circuits

To protect the picture tube from high-density burns, if faults should occur in the vertical deflection, TV01 will short-circuit the voltage from the brightness potentiometer when the vertical deflection fails.

By picture tube flash-overs or too high beam current, TH03 will switch off the horizontal deflection.

To protect the other electronic circuits if picture tube flash-overs should occur, each picture tube electrode has a resistor and a spark gap in order to protect the semi-conductors on the chassis from high voltages or currents.

2.6 Inputs and outputs

All inputs and outputs are connected to a connector K1 at the back of the monitor.

From this connector is also available an unstabilized voltage of +24V.

2.7 Mains supply unit

The monitor is designed to operate from a mains supply of 220 V, 50 Hz.

It is fully mains separated with a full-transformer having two separate secondary windings. One of these feeds the monitor via the stabilizer LM317, the output voltage of which is adjusted to +24 V with PN01. The other secondary winding produces, after rectification, an unstabilized voltage of +24 V and can supply approx. 1,5 A.

EXPLODED VIEW

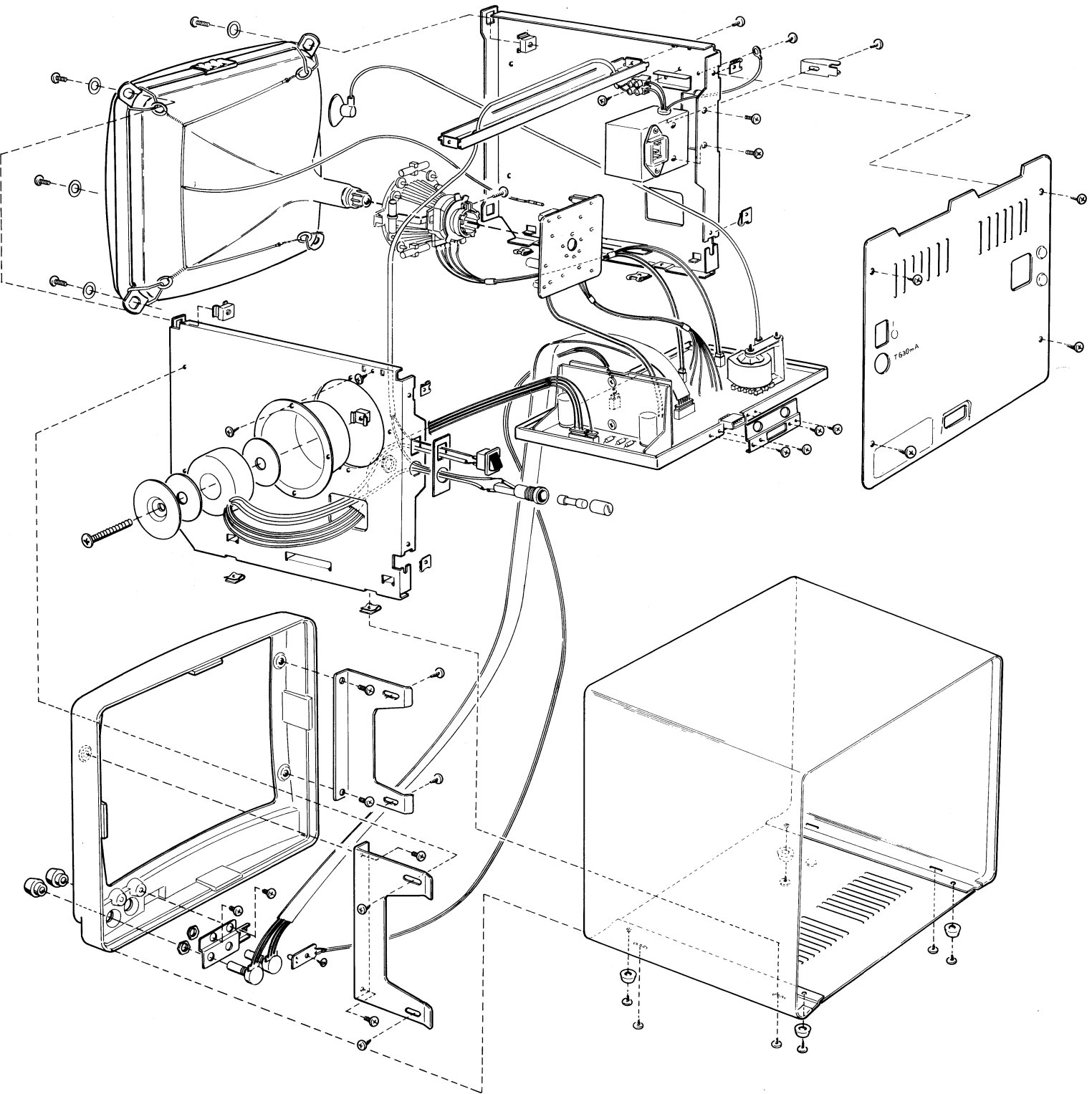

ADJUSTMENT

Adjustment of the working point of the picture tube

1. Adjust the control grid to +20 V by means of the brightness potentiometer.
2. The cathode voltage should be +53 V=.
3. Video amplitude 30 V_{pp} (50 V_{pp} incl. blanking pulse).
4. Adjust the brightness to 150 lumen by means of PH01.

High-resolution graphic displays

High-resolution graphic displays have the following heights and widths:

	Height (mm)	Width (mm)	W/H ratio
ABC 810	185+2	225+2	1.2
ABC 815	166+2	250+2	1.5

P.C.BOARD, MAIN BOARD

PART NO. 55 20808-01

58 10091-01

43 60366-01

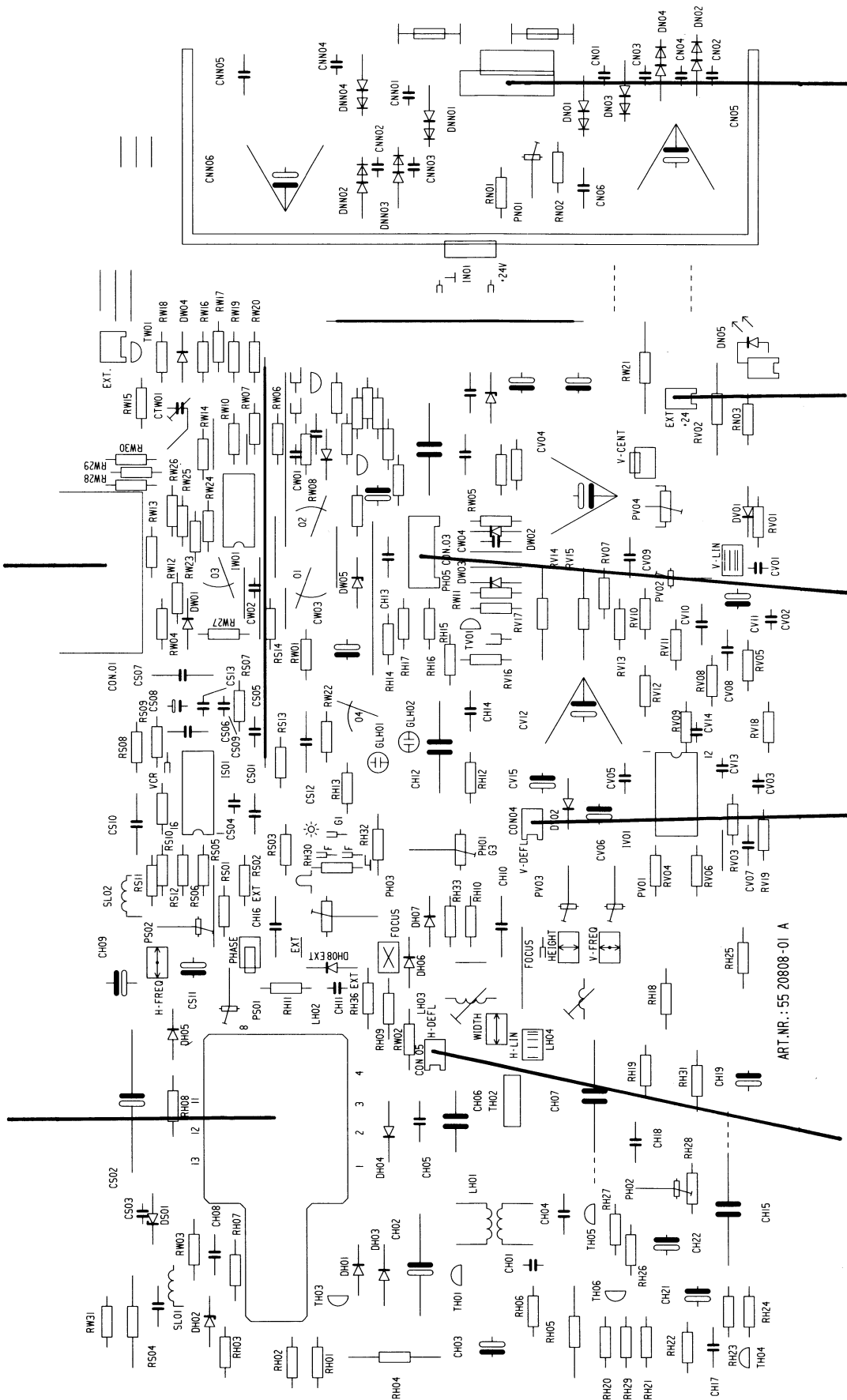

COMPONENT SIDE

43 60170-01

43 60170-02

43 60164-01

43 60170-01

43 60072-01

ART.NR.: 55 20808-01 A

P.C.BOARD, PICTURE TUBE MODULE

PART NO. 55 20809-01

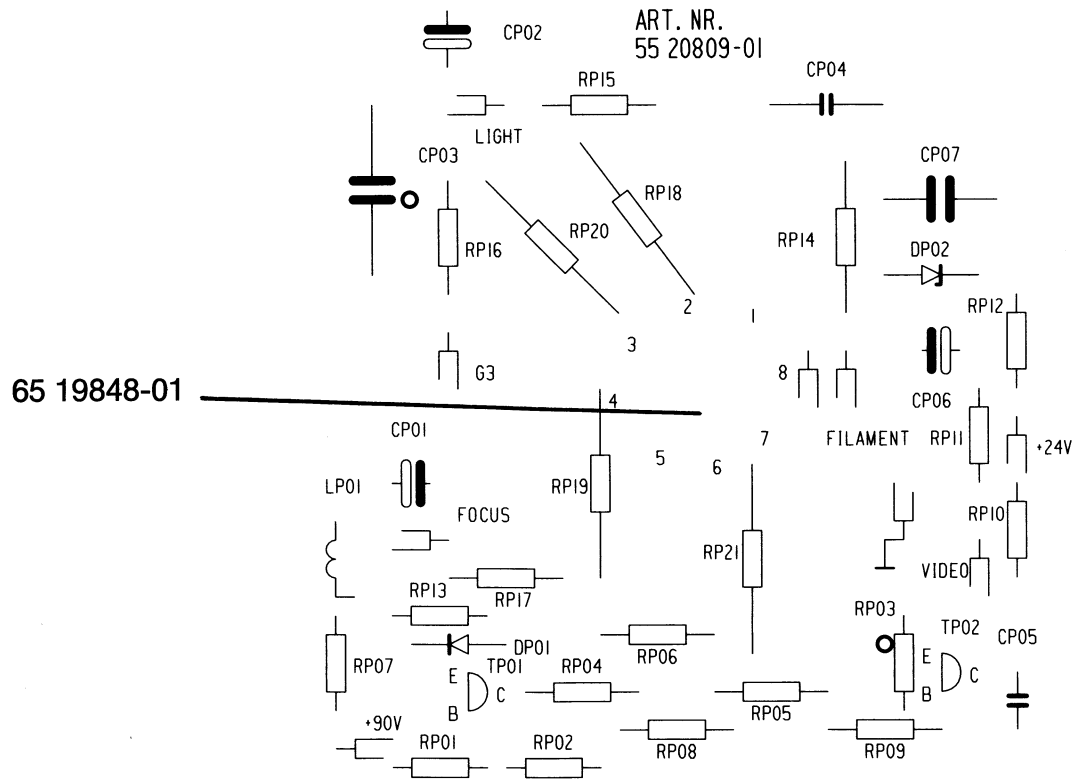

CONNECTOR XP-15

The Monitor Connector

XP-15

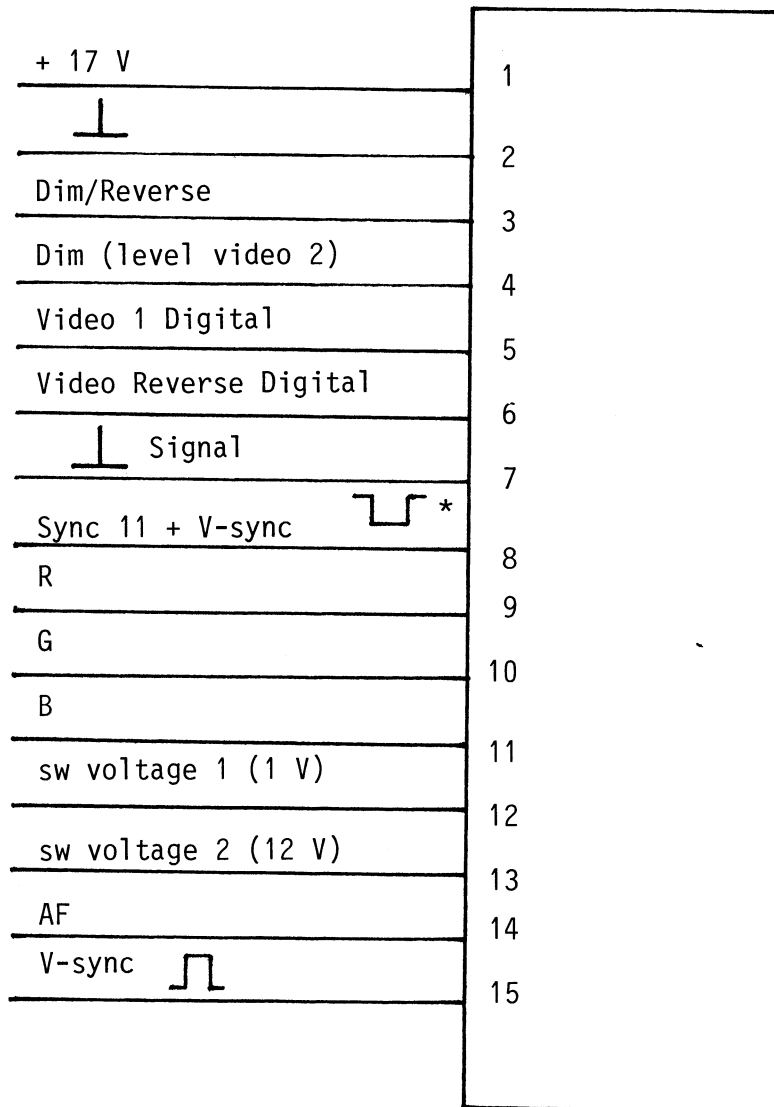



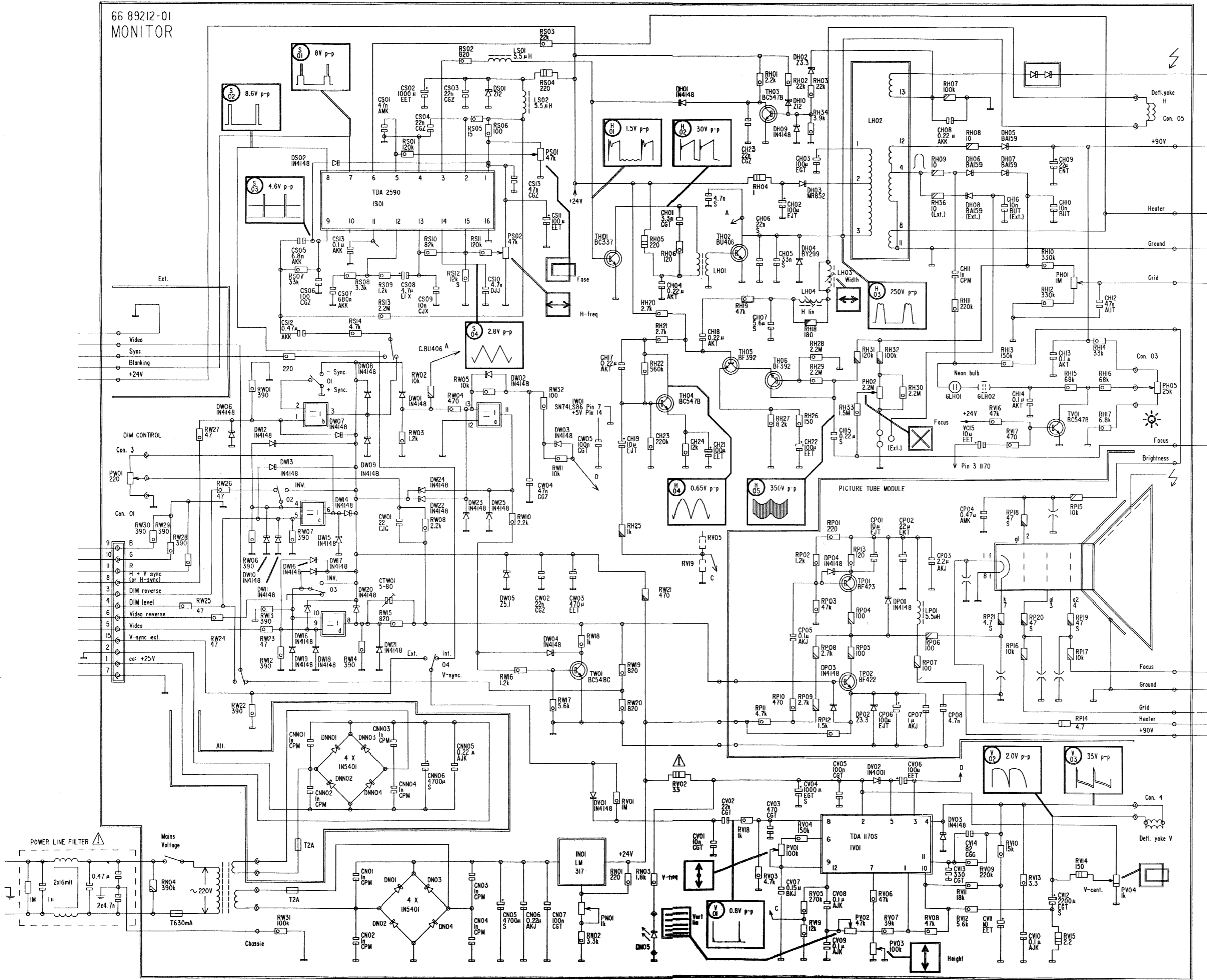

* Sync: If the H-sync and V-sync should be separated
----> 15 V-sync, 8 H-sync.

CIRCUIT DIAGRAM

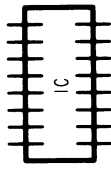

66 89212-01
MONITOR 15" 55 10808-01/809-01
ABC815
LUXOR DATORER AB, MOTALA

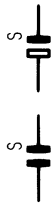
SPARE PARTS LIST

Part Number	Quantity	Description	Part Number	Quantity	Description	Part Number	Quantity	Description
	IS 01	64 30006-01	TDA2591	PN 01	61 17702-01	1k Ω		
	IV 01	64 30008-01	TDA1170S	PH 01	61 80048-01	1M Ω /600V Cer		
	IW 01	64 40036-01	SN74LS86N	02	61 17705-01	47k Ω		
	IN 01	64 50008-01	LM317	03	61 80065-01	2.2M Ω		
	TH 01	63 10012-01	BC337	05	61 70104-01	25k Ω		
	02	63 20025-03	BU206	PS 01,02	61 17705-01	47k Ω		
	03	63 10011-01	BC547B	PV 01,03	61 17706-01	100k Ω		
	04	63 10011-01	BC547B	02	61 17705-01	47k Ω		
	05	63 00027-01	BF392	04	61 80031-01	1k Ω /2W		
	06	63 00027-01	BF392	PW 01	61 70105-01	220 Ω		
	TV 01	63 10011-01	BC547B					
	TW 01	63 10021-01	BC548C	CH 05	62 20011-01	33nF 400V 5%		
	TP 01	63 00036-01	BF423	06	62 20058-01	22nF 400V 5%		
	02	63 00044-01	BF422	07	62 12701-01	5.6 μ F 400V 10%		
	GLH 01	65 60003-01	Glow Lamp	CN 05	62 50162-01	4700 μ F 40V -10% +50%		
	02	65 60003-01	Glow Lamp	CNN06	62 50162-01	"-		
				CV 04,12	62 50128-01	2200 μ F 40V -10% +50%		
				CTW 01	62 80004-01	5-80pF Trimmer		
				RS 12				61 40083-01 12k Ω 0.3W 1%
	DH 01	63 08824-01	1N4148					
	02	63 08746-01	BZX83C3V3					
	03,04	63 40080-01	BY299					
	05-07	63 08751-01	BA159					
	DN 01-04	63 40124-01	1N5401					
	05	63 40057-01	TIL220 LED					
	DNN01-04	63 40124-01	1N5401					
	DS 01	63 40034-01	BZX79C12					
	DV 01	63 08824-01	1N4148					
	02	63 40004-01	1N4001					
	DW 01-04	63 08824-01	1N4148					
	05	63 40060-01	BZX79C5V1					
	DP 01	63 08824-01	1N4148					
	02	63 40052-01	BZX85C4V7					
	LH 01	58 10030-01	Drive					
	02	58 10091-01	Flyback					
	03	59 00396-01	Width					
	04	59 00070-01	Linearity					
	LS 01,02	58 35600-01	5.5 μ H Choke					
	LP 01	58 35600-01	5.5 μ H Choke					

LUXOR
Computers